



NextWindow 2700 Touch Overlay

Installation Guide



V1.4

Table of Contents

Introduction	2
Capabilities	3
Unpacking the Unit.....	4
Installation Instructions	6
USB Installation.....	11
Serial Installation.....	14
Operating the Touch Screen	19
Operating with an Apple Mac Computer	20
Cleaning the Touch Screen	22
Troubleshooting	23
Regulatory Compliance Information.....	26

Terminology

Monitor: refers to the plasma or LCD screen. Sometimes referred to as “display screen.”

Touch overlay: refers to NextWindow’s overlay that fits onto the monitor and provides the touch functionality.

Touch screen: refers to the combined unit—the monitor and the touch overlay.

Introduction

Congratulations on your purchase of a NextWindow 2700 Touch Overlay. This product turns a large-format display, such as a plasma or LCD, into an interactive display. You can control a computer application simply by touching the screen.

The 2700 can be connected to the computer via a serial or USB cable, thus providing maximum versatility. The USB option is HID compliant, providing true plug-and-play operation, just like a USB mouse.

The standard 2700 Overlay is powered via the USB interface from the computer and hence does not require a separate power supply.

To use the serial option, you need to purchase the Serial Pack and also install the serial communications program, which is part of the Touch+ software suite (see below).

The main steps to install the 2700 Touch Overlay are as follows:

- Unpack the 2700 Touch Overlay.
- Fit the touch overlay to the display screen.
- Connect all the cables.
- Perform a simple calibration procedure.

Touch+ Software Suite

For USB communications, you do not need to install any software. However, an optional USB Configuration program that allows you to change various default settings is available in the Touch+ software suite.

Touch+ is provided on a CD with the product and can also be downloaded from NextWindow's website.

Once installed, these programs are available from the Start / Programs / NextWindow Touch+ menu.

Capabilities

The following table shows the touch functionality provided by a NextWindow 2700 with different operating systems.

	XP	Vista	Windows 7		Linux	Mac OS X	Serial
			Starter Home Basic	Home Premium Professional Ultimate			
Single touch ¹	Yes	Yes	Yes	Yes	Yes	Yes	Yes
Digitiser mode ²	No	Yes	No	Yes	No	No	No
Win 7 multi-touch	No	No	No	Yes ³	No	No	No
Multi-touch API ⁴	Yes	Yes	Yes	Yes	No	No	No

Multi-Touch and Gestures on Windows 7

The latest operating systems from Microsoft and other vendors support multi-touch features such as two-touch gestures. NextWindow's 2700 overlay is multi-touch capable and supports gestures. To download the multi-touch driver, visit NextWindow's website.

Application Programming Interface

NextWindow's Application Programming Interface (API) provides functions for developing multi-touch applications. See NextWindow's website for details.

¹ HID-compliant, plug-and-play mouse functionality (click, drag, double-click and right-click).

² HID-compliant USB digitiser.

³ Requires NextWindow driver.

⁴ NextWindow's Application Programming Interface.

Unpacking the Unit

Unpack the unit, taking care not to damage the surfaces.

Check the product for any signs of damage in transit.

Installation Requirements

Once you have unpacked the unit, make sure you have the following:

- The display monitor that you are going to mount the touch overlay onto.
- The computer that runs your software application, including the cable that connects the computer to the display screen.
- The USB or serial cable to connect the touch overlay to the computer.

For the serial option, you also need:

- Serial cable.
- Power adaptor.
- Serial communications software.

Safety Notes

- The touch overlay contains glass that can add significant weight, especially for large-format displays. It is essential that the monitor's stand is strong and stable enough to support the combined weight of the touch overlay and monitor.
- For a large screen, you need two people to install the touch overlay safely.

Parts of the Touch Overlay

The 2700 Touch Overlay consists of aluminium extrusions joined at the corners with cast zinc corner pieces. The electronics and connection sockets are housed in the top bar of the overlay.

Soft padding is provided to protect your monitor when the overlay is fitted to it. The overlay is secured with straps, which allow flexibility for fitting to different manufacturers' monitors.

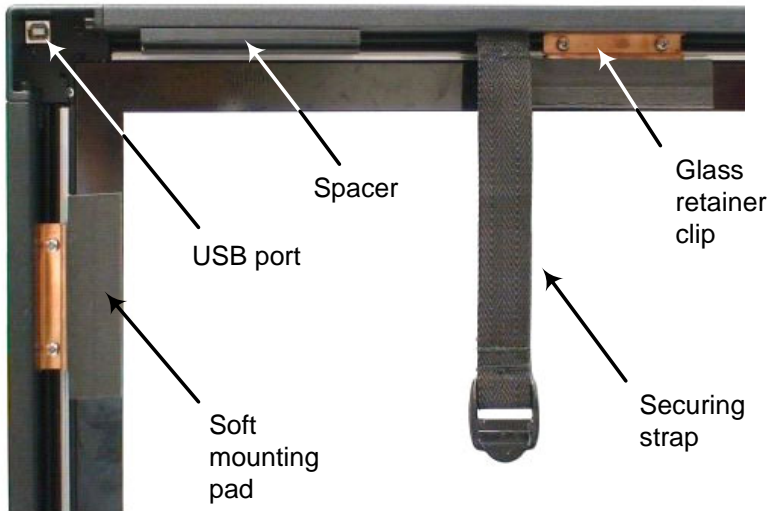

Installation Instructions

Different methods are used for different applications:

- For pedestal-mounted screens, the touch overlay can be fitted to the screen where it stands.
- For wall-mounted screens, the screen may need to be removed from the wall first and then fitted to the touch overlay.

The installation normally requires two people.

Preparation

1. Make sure the monitor is stable and situated so that you can walk all around it.
2. After unpacking and checking for any damage, place the touch overlay face down on a soft surface, such as a clean carpet.
3. Make sure the back surface of the glass is clean.

Important, before you start

- If the display screen's on/off button could be obscured by the touch overlay, make sure the button is in the ON position before you install the overlay, but make sure the screen is turned off by using the remote control unit or wall switch.
- Identify where the air vents are on the monitor so that you can make sure they are not obscured by the overlay or the securing straps.

Spacers

The 2700 overlay comes with suitable spacers for the monitor that it was ordered for. The spacers support the weight of the overlay and also provide for air circulation. All 2700 overlays have one spacer as standard, but up to two extra spacers are required for certain monitors.

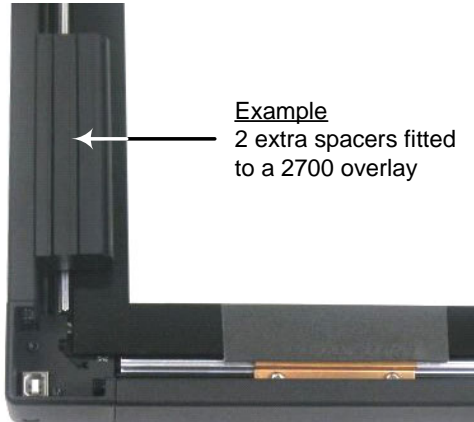

Position the Straps

Make sure the securing straps are fitted to the overlay and if necessary, slide along to suitable positions so that they will not interfere with connections or air vents on the back of the monitor.



Installing on a Pedestal-Mounted Monitor

1. Stand the touch overlay on its bottom edge and carefully flip the top securing straps (the shorter ones) over to the front of the overlay.
2. Lift the overlay onto the monitor at an angle as shown below and locate the top edge first.
3. Lower the bottom edge of the overlay into place.
4. While holding the overlay in place so that it cannot fall off, attach the straps at the rear and pull tight to secure the overlay.

Note: You need two hands to fasten the straps. It is advisable to have someone hold the overlay securely in place while you do this.

Short strap

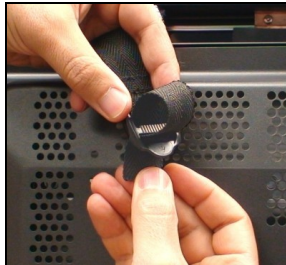
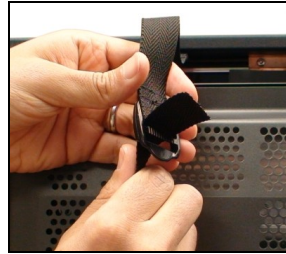
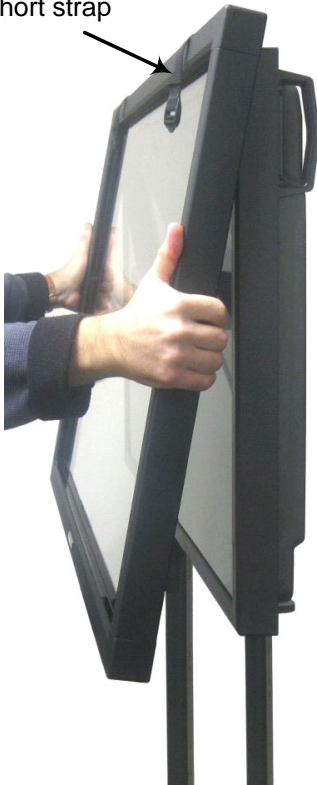

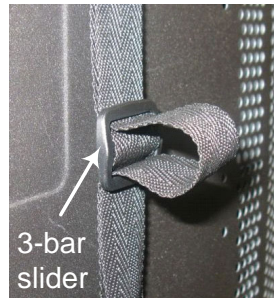

5. Tuck the loose end of the strap into the 3-bar slider provided.

Installing on a Wall-Mounted Monitor

To install the touch overlay on a wall-mounted monitor, first remove the monitor from the wall, and then place it onto the overlay. This will require two people.

Lower the monitor onto the touch overlay, top edge first. Make sure the top is a snug fit, then lower the bottom onto the overlay.

Tighten the straps firmly around the display screen, making sure that they do not cover any connections or air vents.

Re-hanging the monitor

Re-hang the monitor onto the wall, taking care not to dislodge the touch overlay.

Connecting Cables and Switching On

Connect the cables and switch on power in the following order:

1. Connect the video cable from the computer to the monitor.
2. Connect power to the monitor and switch on.
3. Connect power to the computer and switch on.
4. The next part of the installation depends on whether you are using the USB or the serial communications option. The appropriate procedures are described in the following sections.

USB Installation

USB installations require no special software; the touch overlay communicates directly with the computer's operating system via the USB interface, just like a USB mouse.

Connect the USB cable from the touch overlay to the computer.



You can use the Velcro cable-tie provided in order to fasten the USB cable at the back of the monitor.

Once the cable is connected, the computer automatically detects the USB device (the touch overlay) and, after a short pause, displays a series of messages on screen.



(Note: the computer only displays the above message the first time you plug in the USB cable. The next time you plug in the cable, the computer will be already configured for the device.)

For USB communications, you do not need to install any software. However, an optional USB Configuration program is provided that allows you to change the default operating parameters if required (see page 16).

Before operating the touch screen, you need to calibrate it.

USB Calibration

With a clear desktop on the computer,

- Press [Scroll Lock] on the computer keyboard six times,

Or

- Gently push a ballpoint pen into the hole on the side of the unit until you hear a beep.



- The mouse pointer automatically moves to a position at the top left of the screen.
- Touch and hold your finger (or stylus) on the screen at that position until you hear a long beep.
- The pointer moves to three further positions in sequence—top right, bottom right and bottom left. Touch each point in turn until you hear the beep.

This completes the USB calibration procedure. The touch screen is now ready to use.

Calibration notes

- When removing your finger, lift it straight off the screen, making sure you don't drag it across the screen.
- You can exit calibration mode by pressing the calibrate button again or by pressing the [Scroll Lock] key twice.
- Test the calibration by moving the mouse pointer around the screen checking that it closely follows your finger. If the calibration is not satisfactory, you can re-calibrate.

Serial Installation

To use serial communications, you need to purchase the optional Serial Communication Pack from NextWindow.

The Serial Communication Pack consists of a serial cable and a power adaptor. The power adaptor provides power to the touch overlay via a USB connection.



Connecting the Serial Cable

Connect the 4-pole jack plug into the touch overlay.

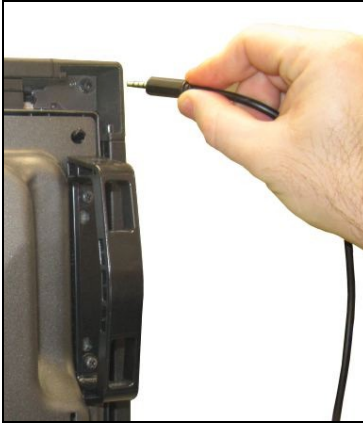

Connect the DB9 serial connector at the other end of the cable into the serial port of the computer.

Connecting the Power Adaptor

With the power switched off at source, plug the adaptor into a power socket.



Connect the USB cable from the touch overlay to the power adaptor.

Switch on the power. The touch screen should now beep when you touch it.

Installing the Serial Communications Software

For the serial option, you need to install software on the computer to provide communications to the touch screen.

The serial utilities are included in the Touch+ Suite, which you can install from the CD that comes with the product or download from NextWindow's website.

The Touch+ Suite installs five programs:

Program Name	Purpose
USB Config	Allows you to change the default USB operating parameters.
Serial Config	Allows you to configure the serial communications and to calibrate the touch screen.
Serial Runtime	Provides serial communications between the touch screen and the computer.
Panel Designer	Allows you to design an off-screen touch panel.
Panel Runtime	Runs the off-screen touch panel.

Once installed, these programs are available from the Start / Programs / NextWindow Touch+ menu.

Running the Serial Runtime program

This program must be running for the touch screen to work in serial mode.

At installation time, you can choose to run this program automatically every time the computer starts. Otherwise, you can start the program via the Start menu.

When the program is running, an icon appears in the computer's system tray (Microsoft Windows). You can click this icon to access the serial configuration and calibration options, or to close the program.



Serial Calibration

With a clear desktop on the computer,

1. Click the serial icon on the taskbar , then select Serial Config.

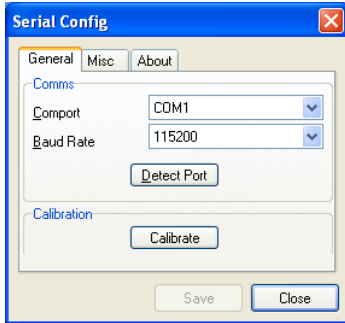

2. Click the [Calibrate] button, then let go of the mouse without moving it.

The program moves the mouse pointer to a position at the top left of the screen and displays the following dialog.

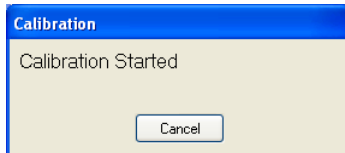

3. Touch and hold your finger on the screen at that position until you hear a long beep.
4. The pointer moves to three further positions in sequence—touch each point in turn until you hear the beep.

This completes the serial calibration procedure. The program displays the following dialog for a few seconds.

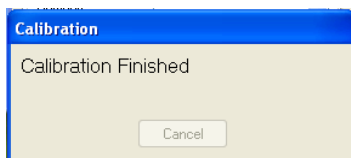

Calibration notes

When moving your finger to the next calibration point, lift it straight off the screen, making sure you don't drag it across the screen.

Test the calibration by moving the mouse pointer around the screen checking that it closely follows your finger. If the calibration is not satisfactory, you can re-calibrate.

Operating the Touch Screen

Mouse actions

NextWindow's 2700 Touch Overlay provides full mouse functionality—click, drag, double-click and right-click.

- Single click is performed by tapping you finger once on the screen.
- Double click is performed by tapping your finger twice on the screen in quick succession.
- Drag is performed by touching and moving your finger across the screen without lifting off.
- Right click is performed by touching and holding your finger in one position for a short time.

The sensitivity of double-click and right-click can be set using NextWindow's USB Config software⁵. You can disable the right-click function completely by setting its response time to zero.

When you touch the screen by default it emits a beep. You can disable this by setting the buzzer time to zero using the USB Config software.

Operating notes

The touch screen does not require pressure to sense a touch.

For best results, point at roughly right angles to the screen and keep the rest of your hand clear of the glass.

When removing your finger, lift it straight off the screen, making sure you don't drag it across the screen.

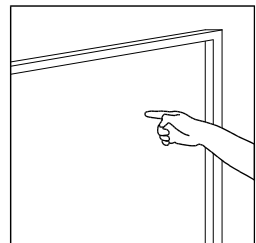

⁵ Part of the Touch+ Suite. See page 16.

Operating with an Apple Mac Computer

To operate with an Apple Mac computer, the 2700 Touch Overlay needs to be in Apple Mac mode.

To Enable Apple Mac Mode

1. With the USB cable connected from the touch overlay to the computer, run the utility program, `Mac_mode_cmd`, which is available on the CD, or download from NextWindow's website.
2. Unplug the USB cable and then plug it back in to register the change.

This puts the touch screen into Apple Mac mode. You then need to calibrate the touch screen before using it.

Calibrating when Connected to an Apple Mac Computer

You can calibrate the 2700 Touch Overlay using the calibration button, which is recessed in a hole on the side of the overlay. Alternatively use the utility program, `Macalib_299`, which is available on the CD, or download from NextWindow's website.

With a clear desktop on the computer,

- Run `Macalib_299`
- Or
- Gently push a ballpoint pen into the hole on the side of the unit until you hear a beep.

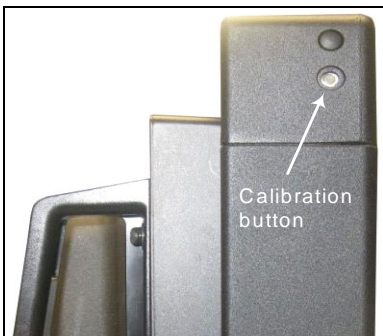

- The mouse pointer automatically moves to a position at the top left of the screen.
- Touch and hold your finger (or stylus) on the screen at that position until you hear a long beep.
- The pointer moves to three further positions in sequence—top right, bottom right and bottom left. Touch each point in turn until you hear the beep.

This completes the calibration procedure.

Calibration notes

- When removing your finger, lift it straight off the screen, making sure you don't drag it across the screen.
- You can exit calibration mode by pressing the calibrate button again.
- Test the calibration by moving the mouse pointer around the screen checking that it closely follows your finger. If the calibration is not satisfactory, you can re-calibrate.

Cleaning the Touch Screen

To clean the touch screen, use a lint-free, soft cloth dampened with standard, household glass cleaning solution as follows:

1. Spray a small amount of glass cleaner onto the cloth.
2. Wipe the glass of the touch screen to remove any dirt, dust, or finger marks.
3. Wipe the clear surfaces around the edges of the screen.
4. Remove any residual glass cleaner with a dry, soft, lint-free cloth.

WARNING:

Do not spray the cleaner directly onto the touch screen as this could leave residue on the optical surfaces.

Do not use an abrasive cleaner or rough cloth as this could damage the optics.

Buzzer Tones

The touch overlay emits the following tones on various actions.

Action	Buzzer Tones
Power up	<beep>
Touch	<beep>
Double touch	<beep> <highest beep>
Touch and hold	<beep> <high beep>
Fault	<long beep> <long beep> <long beep>
Enter calibration mode	<long beep>
Exit calibration mode	<long low beep>

Troubleshooting

This section provides some solutions to possible problems that might occur with the touch screen.

If the problem persists, contact your NextWindow product support provider for further advice.

Touch screen does not respond to touches

Make sure the communications cable (USB or serial) is connected to the computer and to the touch overlay.

Make sure the touch screen is connected to a USB port that provides enough power for it (some peripherals, such as keyboards, include USB ports that do not provide sufficient power for certain devices). Try connecting the touch screen to a different USB port on the computer.

Cursor does not accurately follow your finger

This can occur if the touch overlay has not been calibrated correctly. To fix the problem, re-calibrate the touch overlay—see the relevant sections on USB or serial calibration in this manual.

Unable to calibrate the touch overlay

If you have a problem with calibrating the touch overlay, contact your NextWindow support provider for assistance.

The cursor moves erratically

Make sure there is nothing blocking the optics of the touch screen. There are two sensors in the top corners of the screen that need unobstructed views across the surface of the glass to the bottom and side edges.

Clean the glass and edges of the screen. For instructions, see [Cleaning the Touch Screen](#) on page 22.

“USB not recognized” message appears on screen

To remedy, unplug the USB cable, then plug in the USB cable again. If this does not fix the problem, you may need to uninstall and reinstall the USB device. See the next section.

Uninstalling and Reinstalling the USB Device

1. From the Start menu on Win 7, select:
Settings / Control Panel / System / Device Manager/Universal Serial Bus Controllers

(On XP, select:
Settings / Control Panel / System / Hardware / Device Manager/Universal Serial Bus Controllers)

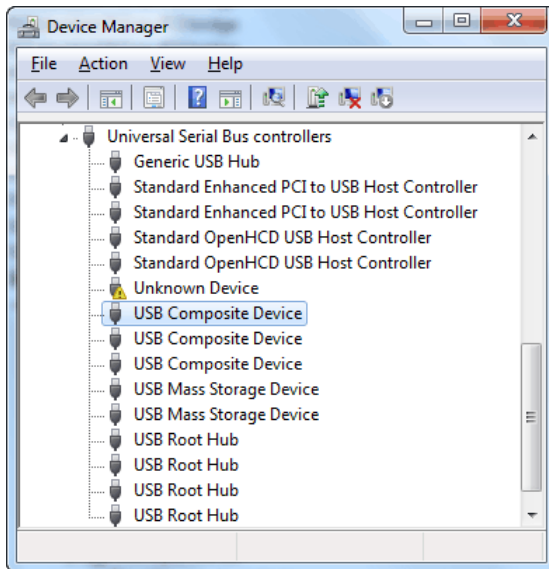

2. Right click on [USB Composite Device] and choose [Properties].

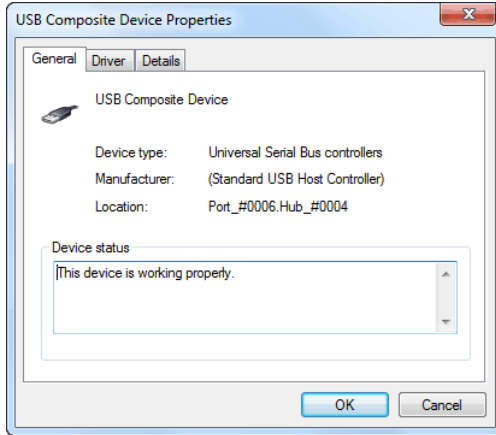

3. On the Properties screen, verify that the location refers to the touch screen.
4. Close the Properties screen.
5. With USB Composite Device selected in the Device Manager list, press [Delete] on your keyboard.

The computer displays the following dialog.



6. Click [OK] to confirm.

This will remove the touch screen from the Hardware Device list. To reinstall the USB device, follow the instructions given in “USB Installation” on page 11.

Regulatory Compliance Information

Federal Communication Commission (FCC) Statement

(For the United States of America.)

This equipment has been tested and found to comply with the limits for a class A digital device, pursuant to part 15 of the FCC Rules. These limits are designed to provide reasonable protection against harmful interference when the equipment is operated in a commercial environment. This equipment generates, uses, and can radiate radio frequency energy and, if not installed and used in accordance with the instruction manual, may cause harmful interference to radio communications. Operation of this equipment in a residential area is likely to cause harmful interference in which case the user will be required to correct the interference at his own expense.

This device complies with Part 15 of the FCC Rules. Operation is subject to the following two conditions: (1) this device may not cause harmful interference, and (2) this device must accept any interference received, including interference that may cause undesired operation.

Changes or modifications not expressly approved by the party responsible for compliance could void the user's authority to operate the equipment.

Damaged Goods

In the event of damage to this Product or packaging you should immediately advise the shipper and the reseller who sold you the product. Retain all original packaging. Future shipment of this product in incorrect packaging may void your warranty.

Limited Warranty

NextWindow Limited (trading as Next Holdings Inc in the United States and NextWindow (UK) Limited in the UK) (Supplier) warrants to the original end-user retail purchaser from an authorized reseller, and each subsequent end-user owner of this Touch Unit (the Product) that the Product will be free from defects in materials and workmanship under normal use and will substantially conform to the specifications and descriptions in the user documentation for 12 months from the date of purchase (the Warranty Period).

If the Product fails to meet the requirements of this warranty and the reseller from whom you purchased the Product receives the Product and all other required information and materials from you before the end of the Warranty Period, Supplier will repair and/or replace (at Supplier's option) the Product.

To claim under this warranty, you must return the Product to the reseller from whom you purchased the Product with proof of purchase. You will be responsible for all shipping and insurance charges. You assume all risk of loss and/or damage to the Product until it arrives at the reseller from whom you purchased the Product's facility. If the reseller from whom you purchased the Product reasonably determines that the Product has not failed to meet the standards of the warranty, you will be liable for the cost of return shipment to you. The reseller from whom you purchased the Product may require payment of such costs before returning the Product to you, and the risk of loss and/or damage will remain with you notwithstanding the reseller from whom you purchased the Product's possession of the Product.

This remedy is the only remedy under the warranty. By exercising this remedy, you waive all other claims arising out of or relating to the failure of the Product to conform to the warranty.

Limitations: This warranty does not apply if the Product has been damaged or rendered defective as a result of incorrect installation, misuse, accident, corrosion, abuse, shipment of this Product in incorrect packaging or other external causes, wear and tear in excess of that normally expected failure of any external resources necessary for the Product's operation, or exposure to water. Repair or attempted repair by any person other than Supplier or one of its approved service centres, commercial use and/or alteration or removal of any serial number each will void this warranty.

Except where Supplier or one of its authorized installers has completed the installation, Supplier assumes no responsibility for damage incurred during installation.

Any implied warranties will only last for 12 months from the date of purchase. Some states and countries do not allow limitations on how long an implied warranty lasts, so the above warranty period may not apply to you. If any limitation or exclusion of liability in this warranty is invalid and Supplier becomes liable for loss or damage that would otherwise have been excluded, such liability will be limited to the total amount actually paid by you for the Product.

You will need to provide proof of purchase showing date, place and serial number at the time you request Warranty service.

Travel costs are specifically excluded on all Products. Travel costs include but are not limited to: taxi, launch fees, aircraft rental, subsistence, customs, shipping and communication charges etc.

Disclaimers and Other Provisions: EXCEPT AS SPECIFICALLY STATED IN THIS LIMITED WARRANTY (A) SUPPLIER PROVIDES THE PRODUCT WITH ALL FAULTS, (B) THE ENTIRE RISK AS TO SATISFACTORY QUALITY, PERFORMANCE, ACCURACY, AND EFFORT IS WITH THE PURCHASER AND USER, (C) SUPPLIER MAKES NO WARRANTY AGAINST INTERFERENCE WITH ANY PURCHASER'S OR USER'S ENJOYMENT OF THE PRODUCT OR AGAINST INFRINGEMENT, AND (D) SUPPLIER DOES NOT WARRANT THAT THE OPERATION OF THE PRODUCT WILL BE CONTINUOUS OR ERROR-FREE. TO THE MAXIMUM EXTENT PERMITTED BY APPLICABLE LAW, IN NO EVENT SHALL NEXTWINDOW OR ITS SUPPLIERS OR LICENSORS BE LIABLE FOR ANY SPECIAL, INCIDENTAL, INDIRECT, CONSEQUENTIAL OR PUNITIVE DAMAGES WHATSOEVER (INCLUDING, WITHOUT LIMITATION, DAMAGES FOR ANY INJURY TO ANY PERSON OR PROPERTY, DAMAGES FOR LOSS OF BUSINESS PROFITS, BUSINESS INTERRUPTION, LOSS OF BUSINESS INFORMATION, LOSS OF PRIVACY, DAMAGES FOR FAILURE TO MEET ANY DUTY INCLUDING THE DUTIES OF GOOD FAITH OR OF REASONABLE CARE, FOR NEGLIGENCE OR ANY OTHER PECUNIARY LOSS) ARISING OUT OF THE USE OF OR INABILITY TO USE THE NEXTWINDOW PRODUCT, THE TECHNOLOGY OR ANY COMPONENT THEREOF OR THE PROVISION OF OR FAILURE TO PROVIDE SUPPORT SERVICES, WHETHER BASED ON CONTRACT, TORT, NEGLIGENCE, STRICT LIABILITY OR OTHERWISE, EVEN IF NEXTWINDOW OR ANY SUPPLIER OR LICENSOR HAS BEEN ADVISED OR IS AWARE OF THE POSSIBILITY OF SUCH DAMAGES. SOME STATES AND COUNTRIES DO NOT ALLOW THE EXCLUSION OR LIMITATION OF INCIDENTAL OR CONSEQUENTIAL DAMAGES, SO THE ABOVE LIMITATION MAY NOT APPLY TO YOU. Each of these disclaimers is in addition to, and does not reduce the effect of, any other disclaimer. No reseller has the authority to change this warranty. No event that voids this warranty will have any effect on these disclaimers or limitations of liability. This warranty will be construed under the laws of New Zealand without regard to any conflict of law rules.

NextWindow Limited (trading as Next Holdings Inc in the United States and NextWindow (UK) Limited in the UK)

43 College Hill
Auckland
New Zealand

www.nextwindow.com

